

MAINTENANCE

Warning: when the filters are obviously with dust or the suction decreases considerably, please clean it promptly, which can improve the working efficiency and extend the life of the cleaner.
Never use the appliance without filter

1 Tear off the mesh

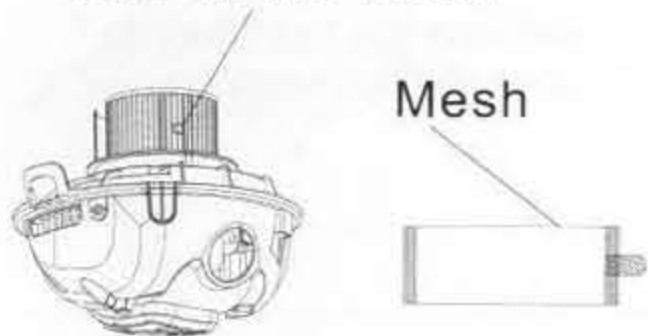

Tear off the mesh outside the HEPA filter

2 Twist the locking knob with a anti-clockwise force, take off the filters

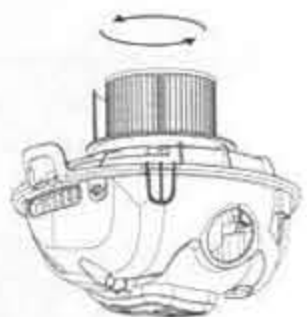

Twist the locking knob with a anti-clockwise force, take off the filters

3 Clean it carefully



Clean it carefully

4 Dry by airing

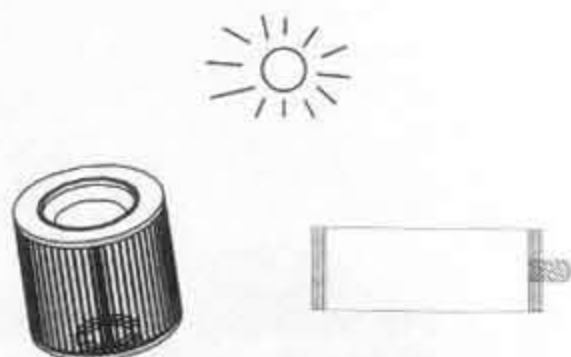

Dry by airing

5 Put back the filter

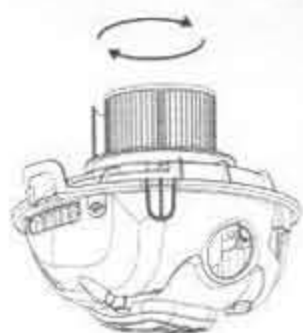

Put back the filter

 **iwata**

INSTRUCTION MANUAL

Wet/Dry Vacuum Cleaner

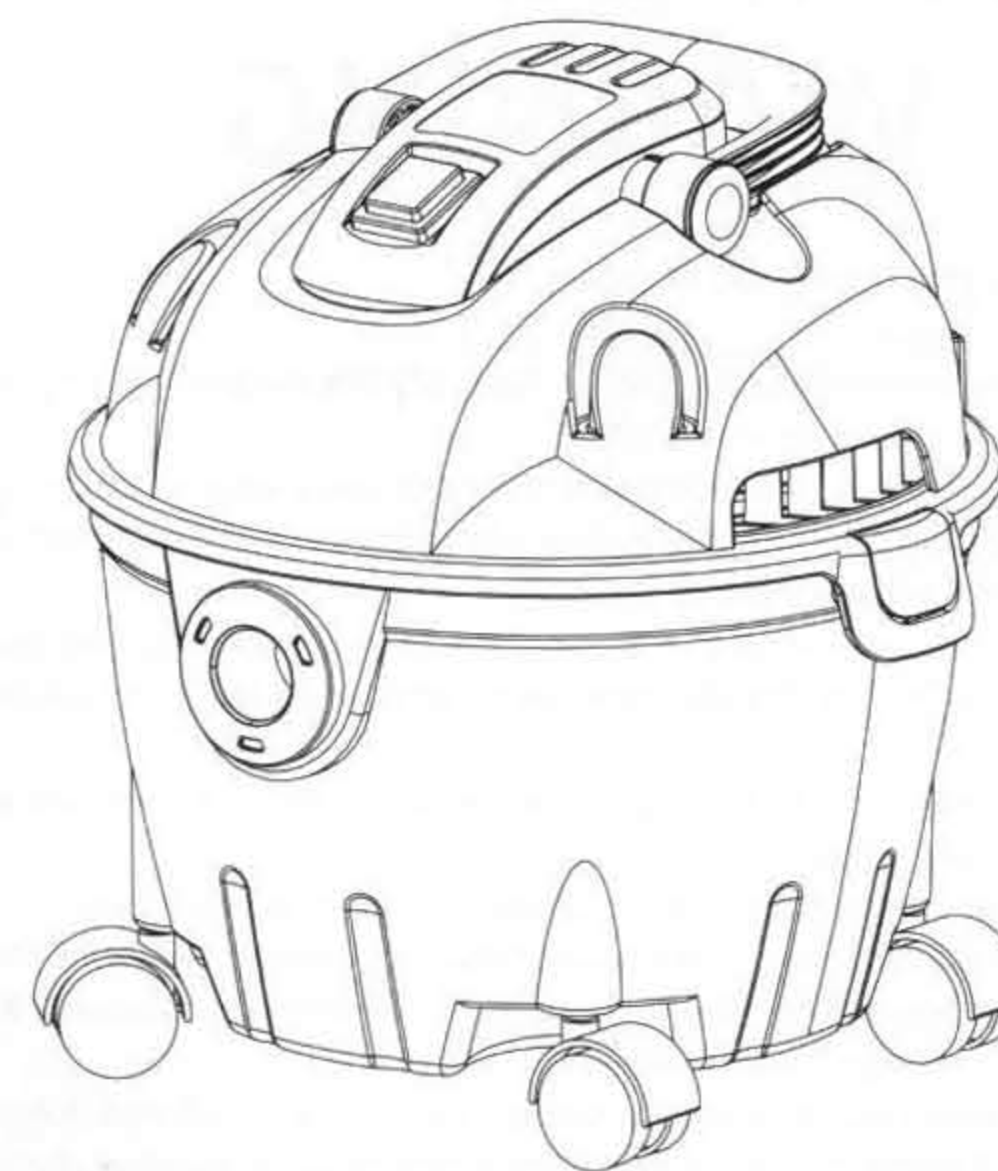

CM13-WDV10L

Please read the instruction manual carefully before operation and well preserve it.

SAFETY DIRECTIONS

IMPORTANT SAFEGUARDS

When using an electrical appliance, basic precautions should always be followed, including the following:

READ ALL INSTRUCTION BEFORE USING THIS VACUUM CLEANER

WARNING

To reduce the risk of fire, electric shock, or injury:

- Do not use outdoors.
- Do not leave vacuum cleaner when plugged in. Turn off the switch and unplug the electrical cord when not in using and before servicing.
- Do not allow to be used as a toy. Close attention is necessary when used by or near children.
- Use only as this manual described. Use only manufacturer's recommended attachments.
- Do not use with damaged power cord or plug.
- Do not pull or carry by cord, use a cord as a handle, close door on cord, or pull cord around sharp edges and corners. Do not run this item over cord. Keep the cord away from heated surface.
- Do not use extension cords or outlets with inadequate current carrying capacity.
- Turn off all controls before unplug.
- Do not unplug by pulling on cord. To unplug, grasp the plug, not the cord.
- Do not handle plug or vacuum cleaner with wet hands or operate without shoes.
- Do not put any object into openings. Do not use with any opening blocked; Keep free of dust, lint, hair, and anything that may reduce airflow.
- This vacuum cleaner creates suction and contains a revolving brush roll. Keep hair, loose clothing, fingers, and all parts of body away from openings and moving parts.
- Do not pick up anything that is burning or smoking, such as cigarettes, matched, or hot ashes.
- Do not use without dust cup or filter in place.
- Use extra care when cleaning on stair.
- Do not use to pick up flammable or combustible liquids such as gasoline, or use in areas where they may be present.
- Store your cleaner indoors in a cool, dry area.
- Ensure you turn the unit off at the very minimum every 15 minutes (for 1 minute) to let the motor cool down - failure to do so may cause motor failure.
- Do not use this unit for more than 4 hours (including rest breaks) on any given day.
- If the supply cord is damaged, it must be replaced by the manufacturer or its service agent or a similarly qualified person in order to avoid a hazard.

PARTS NAME

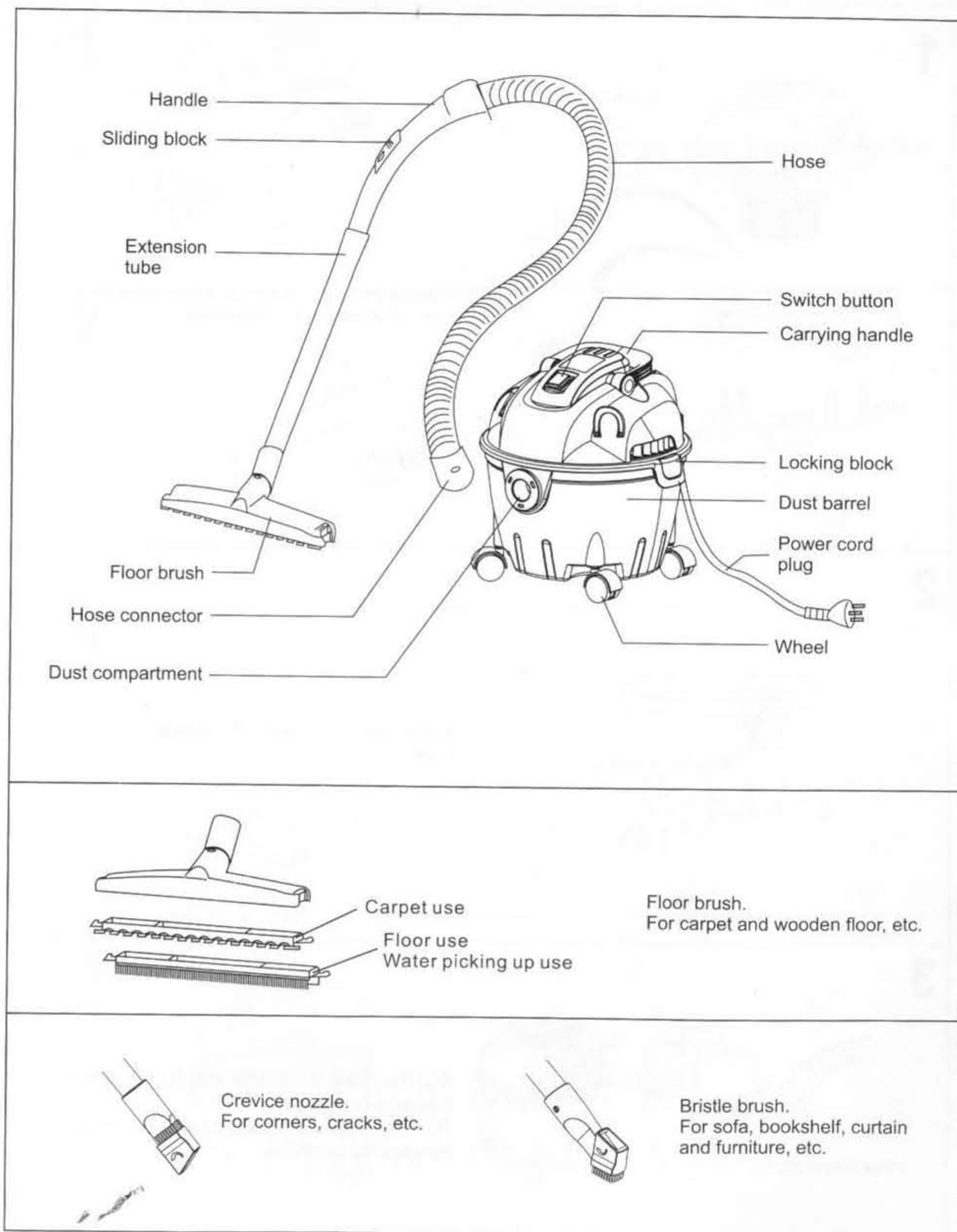

OPERATION METHOD

1

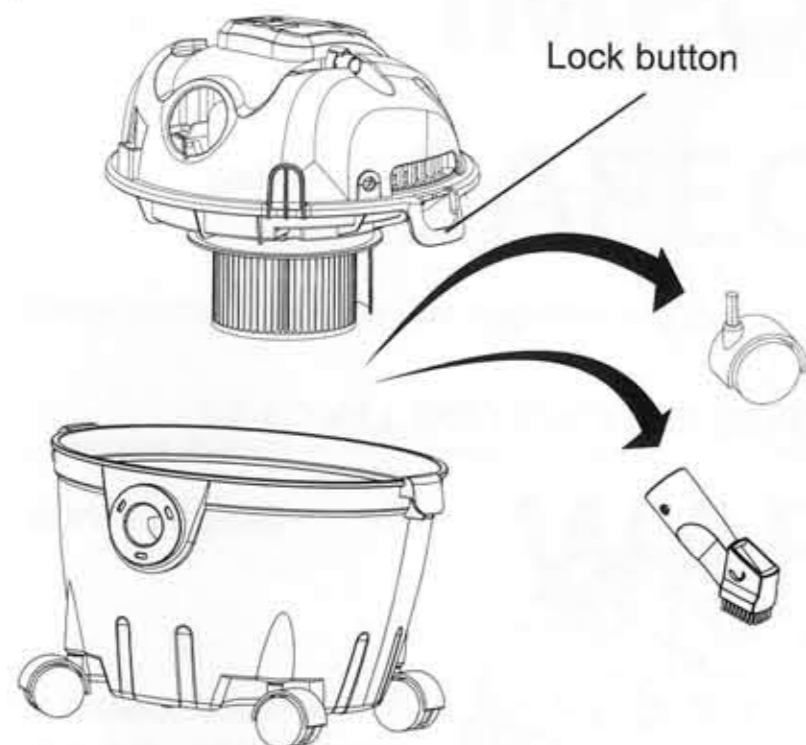

Release the lock block to open the uphousing, take out wheels and accessories

2

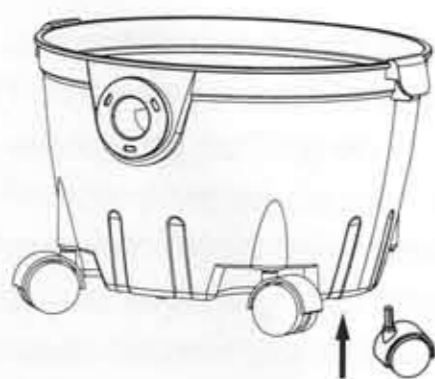

Install castor wheels into the hole on the base.

3

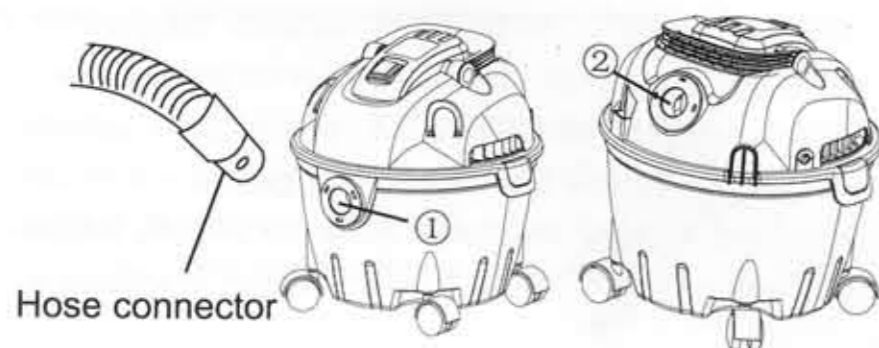

Put the hose connector into ①, the suction function is available
Put the hose connector into ②, the blow function is available

OPERATION METHOD

1

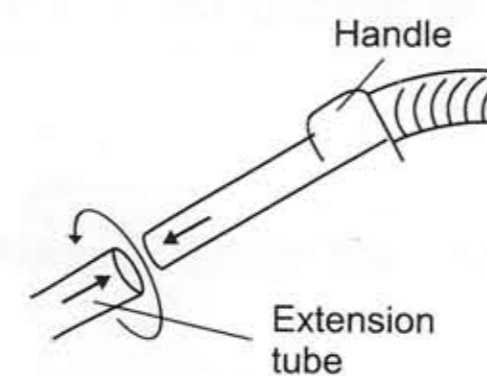

Insert the handle into the tube with a twisting force.

2

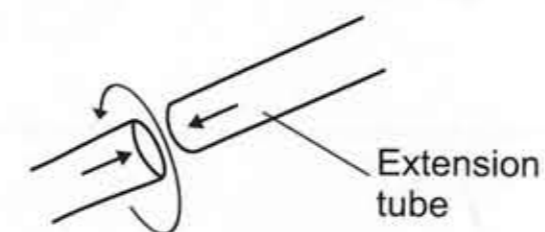

Same as above.

3

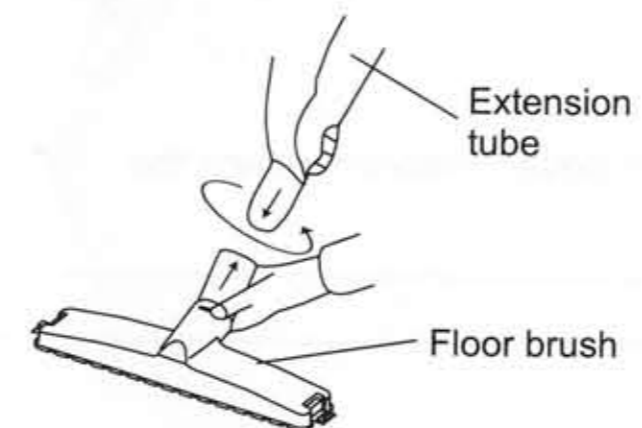

Same as above.

4



Dual storage

OPERATION METHOD

1

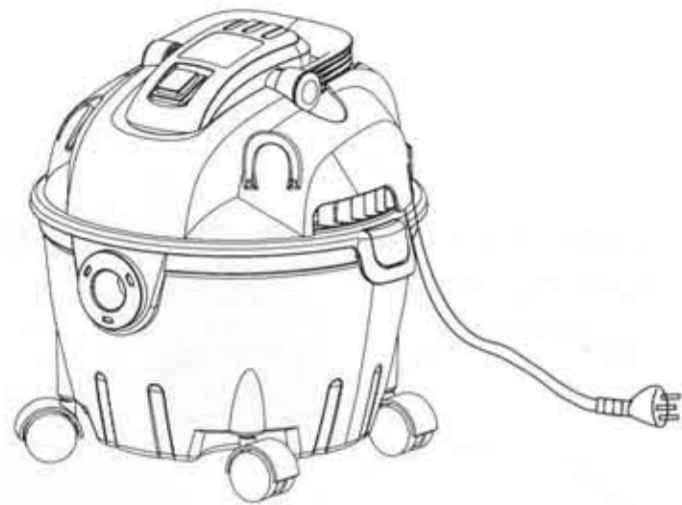

Hold the plug and insert into socket

2

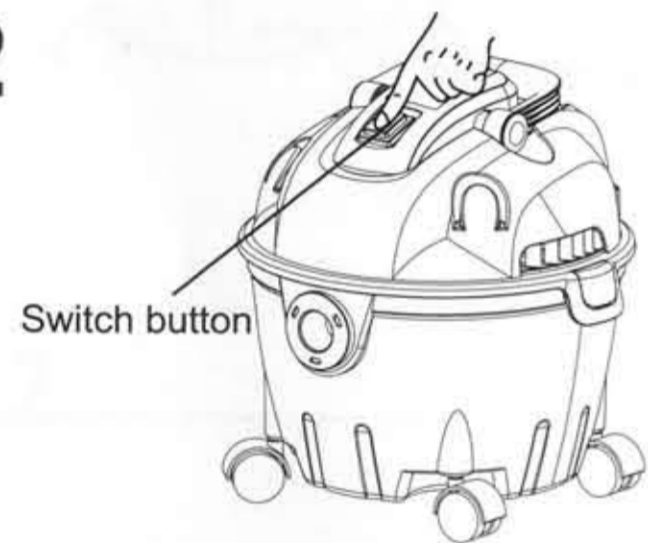

Switch button

Press the switch button to turn on/off the cleaner.

To be safe, there is a water-proof switch cover. Please replace the water-proof cover once find it broken.

3

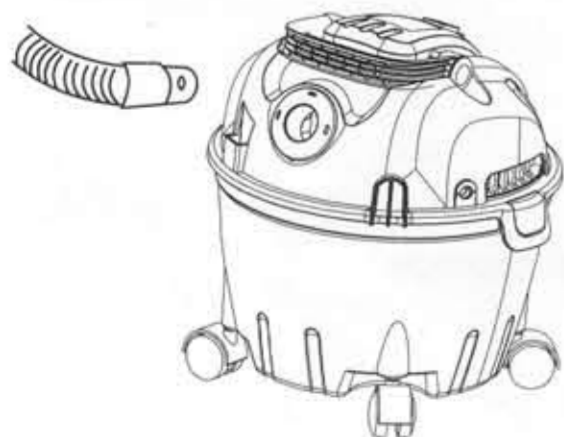

inserting the hose into the exhaust hole: turning on the switch, it can blow off the dust

TO REPLACE DUST BAG

If the dust barrel is full, please empty it as soon as possible

1

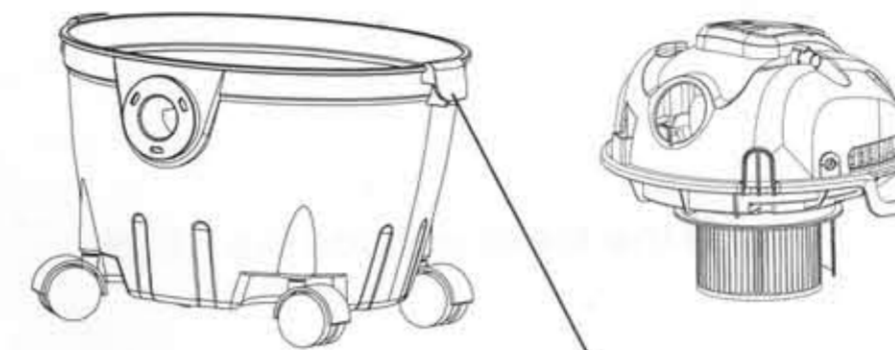

Locking block

Release the lock block to open the up housing

2

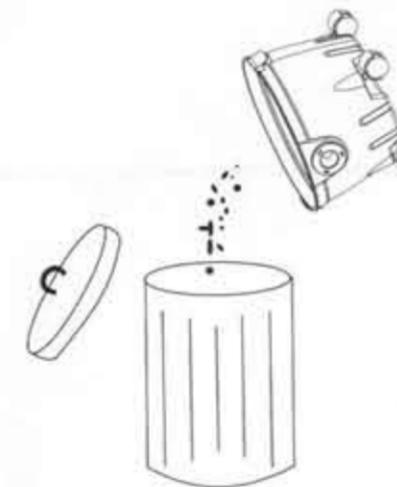

Empty the dust barrel

3



Put back the up housing, and fasten the locking block