

Install method

connect the line

When installing dryer without junction box, you should install above the right side of dryer two-hole standard outlet corresponds to hand dryer. The distance should be 20-50cm.

Please embed junction box without cover in the installation location when directly connecting power cord is needed. Other-wise, power cord will be forced out of body and can not be properly installed.

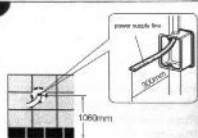

Place metal board

Fix the metal board on wall with screws according to size.

This machine provides a long power cord, please cut off the extra power cord as you need.

Pull out power cord and connect it with power cord of hand dryer as you can see from right map.

Wire connection must be based on the principle, that live wire connects with brown wire, null line connects with blue line, and individually wrapped with insulation tape to ensure no leakage.

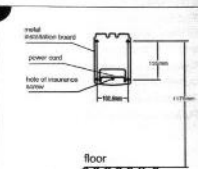

Installation of body

Visual orientation, and make main body hanging on the metal plate on wall.

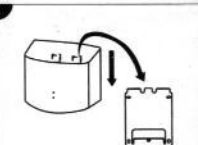

Fix the body

Do as map indicated, press slightly on the body.

And then pull out filter box, aiming at hole of insurance screw use cross screwdriver to turn on one screw at an angle of 45 degree, until the hand dryer is fixed firmly.

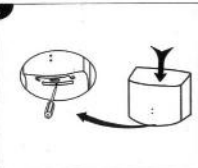

Test run

Steps	Confirm information	Check & Notice
1. Shake the machine gently	The machine is installed firmly without shaking	It will occur shaking and noisy when the machine doesn't install firmly
2. Confirm the power and voltage	Please use the rated power supply	It will burn out machine or cause human accidents if the power use incorrect
3. Switch on the power	Close external power supply switch or insert the power plugs	Power socket must be match the machine plug Please check the power when the indicator light not bright
4. Hold in your hands to drying	High speed wind blow out	Please confirm whether your hands are far away from the sensor parts if there is no wind blowing out

Daily use and maintenance

External maintenance

Screw with a soft dry cloth or towel Sassafra. Please use neutral detergent. Please don't use organic solvents, acid or alkali toilet cleaner, cleaning brush etc.

Otherwise, the machine will destroy machine surface finish or produce discoloration.

If using a chemical cloth, make sure that the use of attention.

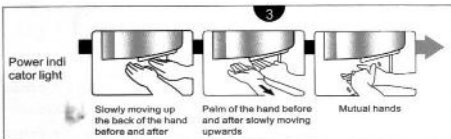
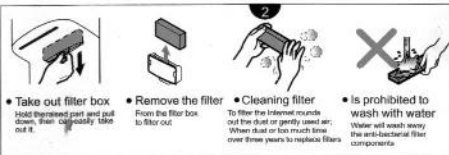
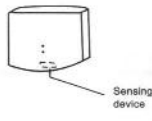

Packing list

main machine 1
5x25mm self tapping screw 4
5mm expansion pipe 4

User manual 1

iwata

HAND DRYER

JET-M5

USER MANUAL

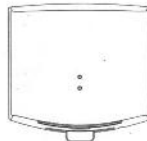

For after-sales service:

Website: www.colentco.com

Landline: (632) 442-3866; 412-6155;

413-8819; 442-3856; 448-7674

Mobile: 0923-5345681; 0917-3079188;

0920-9746874

Email: sales_mktg@colentco.com,

iwata@colentco.com,

iwata2@colentco.com,

iwata3@colentco.com

Specification

Voltage	AC220-240V~	Motor	Brush motor
Phase	Single-phase	Sensing distance	15-20cm
Input	1400-1650W	Protection class	IPX1
Wind speed	105m/s	Appearance size	250x165x245mm
Heating power	800-950W	N.W	3.7kg



WARNING

If you don't use this unit properly or follow the safety guidelines carefully, it would lead to serious personal injury or property damage.



Prohibited



Do not allow
The unit get
wet



Do not use in
the bath/shower room



Prohibit
disassembling



Please do
complying
with instruction



Warning

- Do not open the front panel. Otherwise, this may get an electric shock.
- Do not let children hang from the unit. otherwise, this may cause the unit to drop.
- Do not allow the unit get wet. otherwise, it will cause electric shock.
- Do not use in a wet environment, for example, near the bathroom where it may get the direct water and the places where the condensation may form. Otherwise, this may cause electric shock and unit malfunction.
- Do not modify and disassemble the unit unnecessarily. Otherwise, this may cause a fire, electric shock, or personal injury.
- Rated power is required.
- If power tolerance is over +/-10%, there will be breakdown if using incorrect power supply, fire, electric shock and machine malfunction will happen.
- Please use dedicated socket.
- If using together with other appliances, the socket may cause abnormal heat leading to fire.
- Power must be cut off when maintenance to prevent the risk of electric shock.
- Air filter must be installed.

- If the machine doesn't work or have abnormal conditions, please cut off power to prevent accidents; and close leakage circuit breaker and ask supplier to check and repair, or it may lead to fire because of electricity leakage and short circuit.

Attention when installation:

- Do not install when the machine are power connected.
- This appliance is not intended for use by persons (including children) with reduced physical, sensory or mental capabilities, or lack of experience and knowledge, unless they have been given supervision or instruction concerning use of the appliance by a person responsible for their safety.
- If the cord is damaged, it must be replaced by the manufacturer, its service agent or similarly qualified persons in order to avoid a hazard.
- For additional protection, the installation of a residual current device (RCD) having a rated residual operating current not exceeding 30mA is advisable in the electrical circuit supplying the bathroom. Ask your installer for advice.



- Environmental Protection
Waste electrical products should not be disposed of with household waste.
Please recycle where facilities exist.
Check with your Local Authority or retailer for recycling advice.

Feature

- No touch hand drying ensures complete hygiene
- NO need paper towels, ease of maintenance
- Auto-stop function. the built-in timer will stop the unit after 45 seconds.
- The machine equipped with automatic heating system, when temperature was cold, automatically open the heating system, when the temperature was hot, the heating system. automatic shutdown.

Name of each part

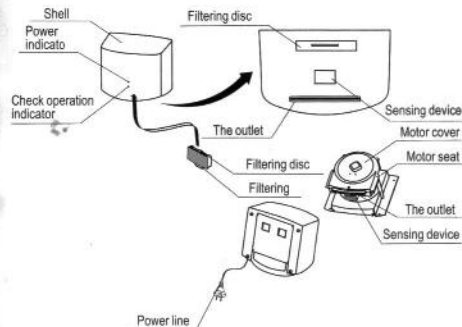

Electrical diagram

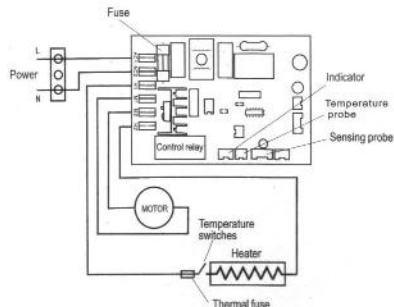

Precautions before installation and installation location

- Do not install in the following places (otherwise may cause malfunction).
 - Place with temperature below -10°C or over 40°C
 - Place directly sprinkled by water
 - Place with direct sunlight, strong light
 - Place easy for condensation
 - Place filled with corrosive, oxidizing and reducing gas
 - Place with altitude over the range of 0 ~ 2000m
- Installation location
 - The following picture shows the recommended location. (If there is floor or obstacles below the hand dryer, the distance between machine and floor or obstacles should be at least 400mm.)
 - Keep the right side of dryer away from mirror or wall for the water droplets may splash out when you dry hands. (the distance should be 100mm above.)
 - Please avoid the place easy to meet people and easy to encounter doors.
 - Please select flat wall to install this product.

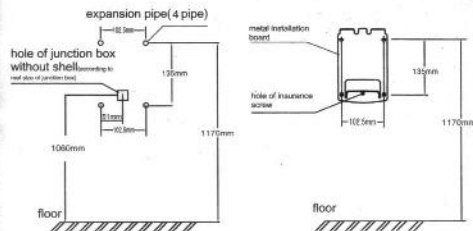

- Power cord should be $1\text{mm}^2 \sim 1.5\text{mm}^2$.